







Componentes	Qtd	Componentes	Qtd	Componentes	Qtd
Placa de fixação superior p/ madeira 	2	Batente de amortecimento 	2	Amortecedor p/ madeira 	2
Pino guia p/ madeira 	1	Chave Allen 2 mm 	1	Parafuso 4x16 cabeça escareada phillips 	8

Trilho superior duplo

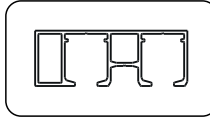

1. Dimensionamento das portas

- Parâmetros de instalação**
- Peso máximo da porta: 15 kg;
 - Largura mínima da porta: 520 mm;
 - Espessura da porta: 15 ou 18 mm.

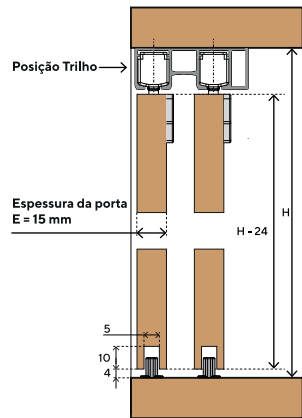

Porta de 15 mm

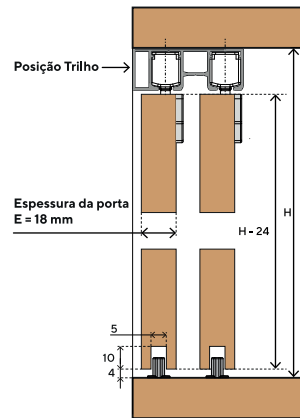

Porta de 18 mm

2. Furações

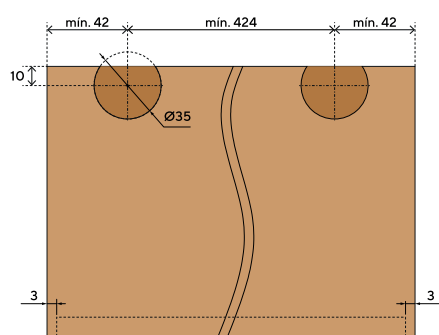

A espessura mínima das bases inferior e superior do armário deve ser 18 mm.

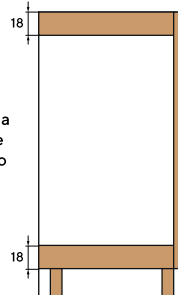

3. Instalação batente e amortecedor

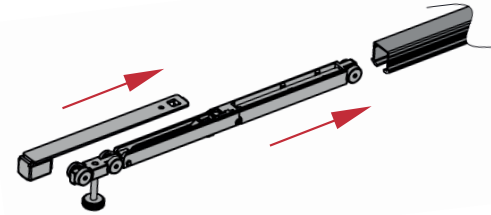

4. Instalação trilho e pino guia

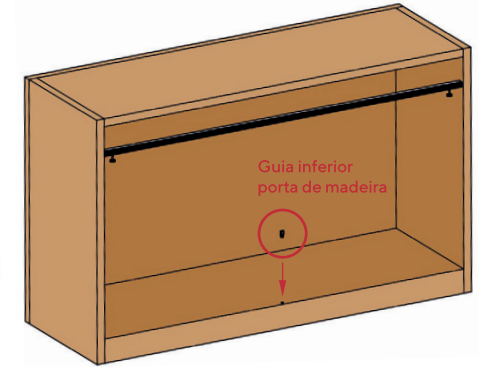

5. Instalação placa e trilho guia inferior

Faça as furações conforme indicado, fixe as placas superiores e encaixe o trilho guia na parte inferior da porta.

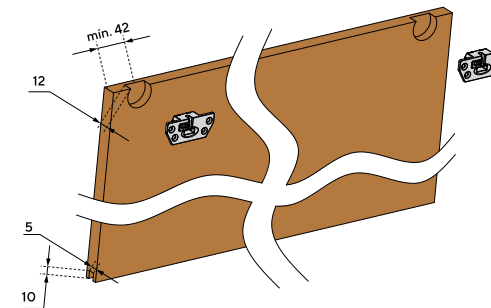

6. Instalação da porta

Encaixe o parafuso de suspensão nas placas superiores, acionando a trava para fixar.

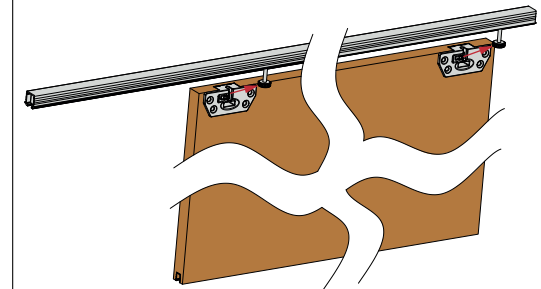

7. Ajustar posição do batente e fixar

Ajuste a posição do batente para permitir que o amortecedor funcione completamente e feche a porta.

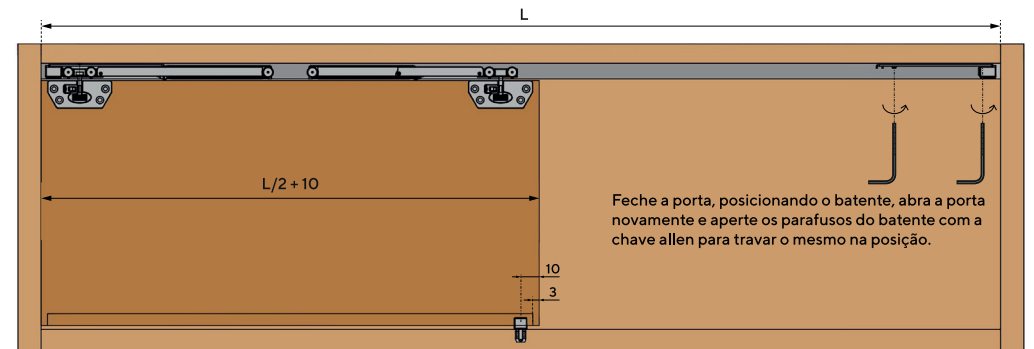

Feche a porta, posicionando o batente, abra a porta novamente e aperte os parafusos do batente com a chave allen para travar o mesmo na posição.